



XDVD700

INSTALLATION/OWNER'S MANUAL

DVD Multimedia Receiver with 7" Touch Screen Display



Safety Notes:

The DVD video display of the in-dash unit will not operate while the vehicle is moving. This is a safety feature to prevent driver distraction. In-dash DVD video functions will only operate when vehicle is in Park and the parking brake is engaged. It is illegal in most states for the driver to view video while the vehicle is in motion.

Copyright Notes

This product incorporates copyright protection technology that is protected by method claims of certain U.S. patents and other intellectual property rights owned by Macrovision Corporation and other rights owners. Use of this copyright protection technology must be authorized by Macrovision Corporation, and is intended for home and other limited viewing uses only unless otherwise authorized by Macrovision Corporation. Reverse engineering or disassembly is prohibited.

Manufactured under license from Dolby Laboratories. "Dolby" and the double-D symbol are trademarks of Dolby Laboratories.

Windows Media and the Windows logo are trademarks, or registered trademarks of Microsoft Corporation in the United States and or other countries.

All other trademarks are property of their respective owners.

Table of Contents

	Page
DVD Region Management	2
Warning Statement	3
Safety Information/Precautions	4
Preparation/Mounting/Wiring	5-7
Remote Control Overview	8
Control Locations - Monitor Closed	9-10
Control Locations - Monitor Open	11-12
Control Locations - Remote	13-14
General Operation	15-18
General Setup Menu	19-22
Screen Setup	23-24
Language Setup	25-26
Video Setup	27
Rating Setup	28
AM/FM Tuner Operation	29-32
Warning Statement	33
DVD Operation	34-40
CD Operation	41-45
MP3/WMA Operation	46-49
Media Compatibility Information	50-51
Warranty	52
Troubleshooting	53
Specifications	54

DVD Region Management

Some DVD discs can be played only in certain playback modes according to the intentions of the software. As the XDVD700 plays discs according to their intentions, some functions may not work as intended. Please be sure to read the instructions provided with each disc. This player has been designed to play back DVD software that has been encoded for specific region areas. It cannot play back DVD software encoded for other region areas than the region areas for which it has been designed.

The XDVD700 will play discs labeled "Region 1" or "All".

DVD region codes:

- 1 - USA, Canada
- 2 - Japan, Europe, South Africa, Middle East
- 3 - Rep. of Korea, Taiwan, Hong Kong, Parts of Southeast Asia
- 4 - Australia, New Zealand, Mexico, South America
- 5 - Eastern Europe, Russia, India, Africa
- 6 - China





XDVD700 PREPARATION

⚠ WARNING ⚠

Upon installation of this Monitor/DVD player (“unit”) into a vehicle, the driver of the vehicle must not operate this unit by watching videos or playing video games while driving. Failure to follow this instruction could lead to driver distraction which could result in serious injury or death to the vehicle’s occupants or persons outside the vehicle and/or property damage.

Several states prohibit the installation of monitors/DVD players if the screen is visible from the driver’s seat. If you reside in a jurisdiction which has enacted such a law, this unit must not be installed so that the screen is visible from the driver’s seat. When installing this unit in the front console/dashboard, the unit must be positioned so that it is facing the front passenger seat only. Failure to follow this instruction could lead to driver distraction which could result in serious injury or death to the vehicle’s occupants or persons outside the vehicle and/or property damage.

This unit is designed so that it may be operated only when the vehicle is in “Park” and the parking brake is fully engaged. To this end, this unit includes a parking brake lock-out feature which prohibits the unit from operating if the vehicle is not in “Park” and/or the parking brake is not fully engaged. When installing this unit, the installer must connect the parking brake detect wire (“Yellow-Blue Lead”) to the parking brake mechanism in order to make the parking brake lock-out feature operable. **DO NOT** simply ground the parking brake detect wire to a metal portion of the vehicle. Failure to properly install the parking brake lock-out feature could lead to driver distraction which could result in serious injury or death to the driver’s occupants or persons outside the vehicle and/or property damage.

Once the parking brake lock-out feature is installed, the owner/user must not attempt to disrupt/neutralize the parking brake lock-out feature by (a) partially engaging the parking brake and/or (b) purchasing/using any device or unit designed to send necessary brake signals to the unit. Failure to follow these instructions could lead to driver distraction which could result in serious injury or death to the driver’s occupants or persons outside the vehicle and/or property damage.

When operating this unit, keep the unit’s volume level low enough so that the vehicle’s occupants can hear traffic-related sounds such as police and emergency vehicles. Failure to follow this instruction could lead to driver distraction which could result in serious injury or death to the vehicle’s occupants or persons outside the vehicle and/or property damage.

Safety Information

Please read all instructions carefully before attempting to install or operate.

Due to its technical nature, it is highly recommended that your DUAL XDVD700 is installed by a professional installer or an authorized dealer. This product is only for use in vehicles with 12VDC negative ground only.

Safety Notes:

The DVD video display of the in-dash unit will not operate while the vehicle is moving. This is a safety feature to prevent driver distraction. In-dash DVD video functions will only operate when vehicle is in Park and the parking brake is engaged. It is illegal in most states for the driver to view video while the vehicle is in motion.

To prevent damage or injury:

1. Make sure to ground the unit securely to the vehicle chassis ground.
2. Do not remove the top or bottom covers of the unit.
3. Do not install the unit in a spot exposed to direct sunlight or excessive heat or the possibility of water splashing.
4. Do not subject the unit to excessive shock.
5. When replacing a fuse, only use a new one with the prescribed rating. Using a fuse with the wrong rating may cause the unit to malfunction.
6. To prevent short circuits when replacing a fuse, disconnect the wiring harness first.
7. Use only the provided hardware and wire harness.
8. You cannot view video while the vehicle is moving. Find a safe place to park and engage the parking brake.
9. If you experience problems during installation, consult your nearest DUAL dealer.
10. If the unit malfunctions, reset the unit as described on page 12 first. If the problem still persists, consult your nearest DUAL dealer or call tech assistance @ 1-866-382-5476.
11. To clean the monitor, wipe only with a dry silicone cloth or soft cloth. Do not use a stiff cloth, or volatile solvents such as paint thinner and alcohol. They can scratch the surface of the panel and/or remove the printing.
12. When the temperature of the unit falls (as in winter), the liquid crystal inside the screen will become darker than usual. Normal brightness will return after using the monitor for a while.

Additional Notes:

1. When extending the ignition, battery or ground cables, make sure to use automotive-grade cables or other cables with an area of 0.75mm (AWG 18) or more to prevent voltage drops.
2. Do not touch the liquid crystal fluid if the LCD is damaged or broken. The liquid crystal fluid may be hazardous to your health or fatal. If the liquid crystal fluid from the LCD contacts your body or clothing, wash it off with soap immediately.

This device complies with part 15 of the FCC rules and regulations.

Operation is subject to the following two conditions:

- 1) This device may not cause harmful interference, and
- 2) This device must accept any interference received, including interference that may cause undesired operation.

Preparation

Please read entire manual before installation.

Before You Start

- Disconnect negative battery terminal. Consult a qualified technician for instructions.
- Avoid installing the unit where it would be subject to high temperatures, such as from direct sunlight, or where it would be subject to dust, dirt or excessive vibration.

Getting Started

- Slide the unit out of the mounting sleeve.
- Install mounting sleeve into opening, bending tabs to secure.
- Connect wiring harness and antenna as shown on pages 6-7. Consult a qualified technician if you are unsure.
- Certain vehicles may require an installation kit and/or wiring harness adapter (sold separately).
- Test for correct operation and slide unit into mounting sleeve.
- Attach unit to mounting sleeve using supplied #1 Phillips screws.
- Snap trim ring into place.
- Mount the iplug™ adapter to any smooth clean surface using the supplied double-sided tape or Phillips head screws.

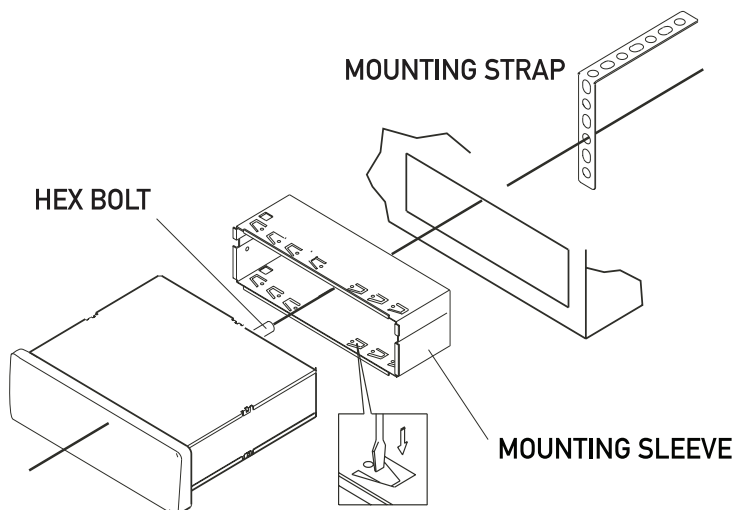
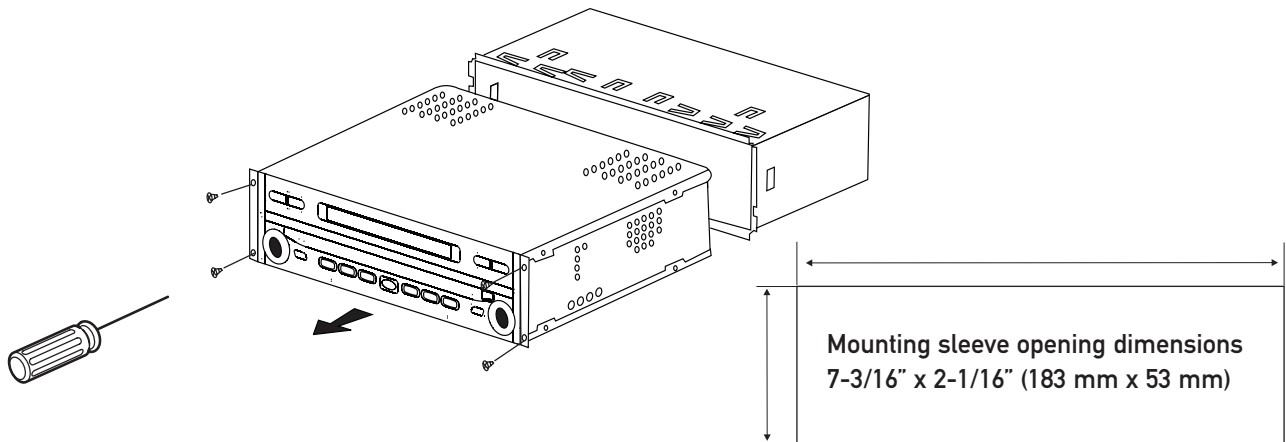

TYPICAL FRONT-LOAD DIN MOUNTING METHOD

Expanded Wiring Diagram - Inputs/Outputs

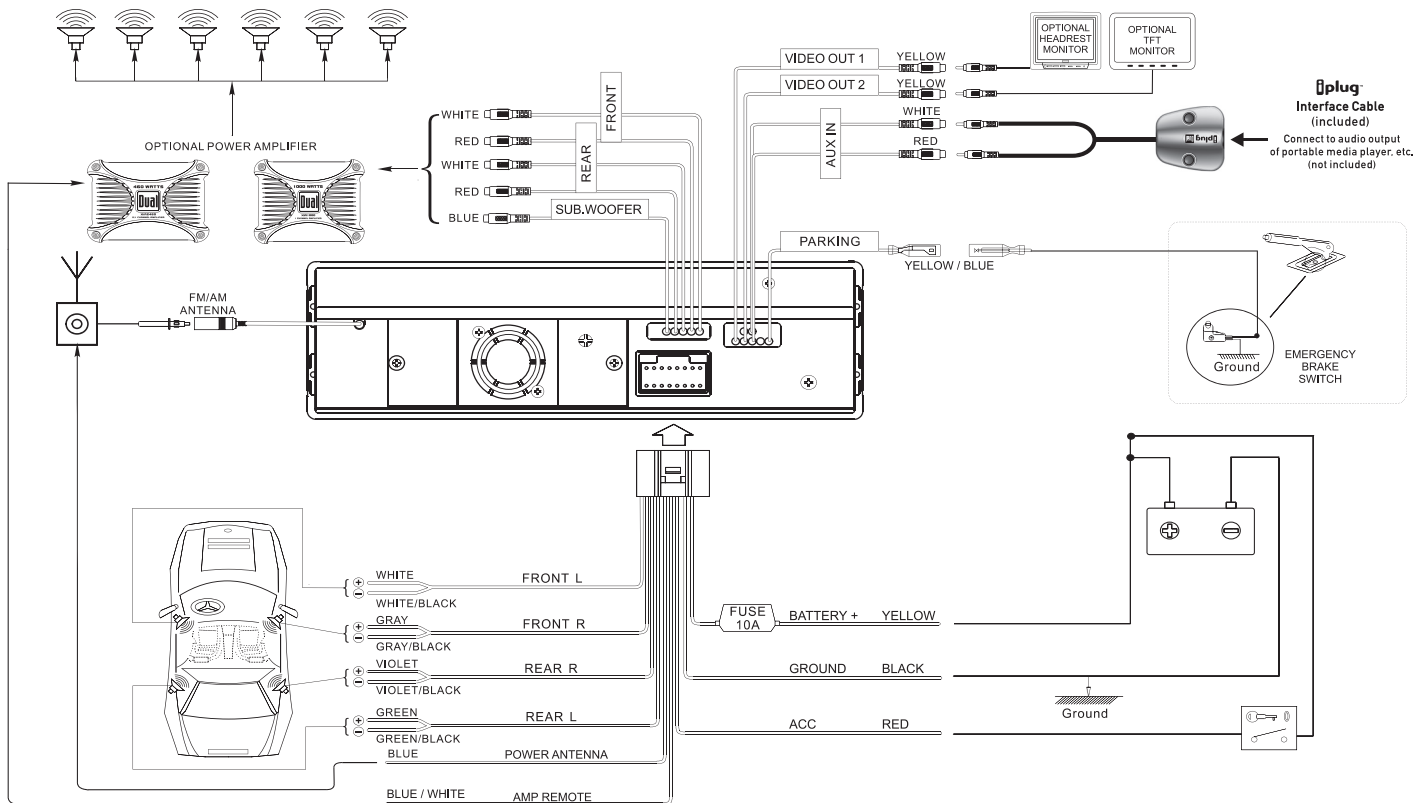

Wiring Notes:

Subwoofer output

The **SUBWOOFER** audio output (Blue RCA) is active in all audio modes and must be connected to an external amplifier.

NEED HELP??

Call our Technical Service Hotline, 1-866-382-5476.

Safety Notes:

The DVD video display of the in-dash unit will not operate while the vehicle is moving. This is a safety feature to prevent driver distraction. In-dash DVD video functions will only operate when vehicle is in Park and the parking brake is engaged. It is illegal in most states for the driver to view video while the vehicle is in motion. Altering or defeating this safety feature is a violation of law and is prohibited.

Wiring Diagram - Optional A/V Connections

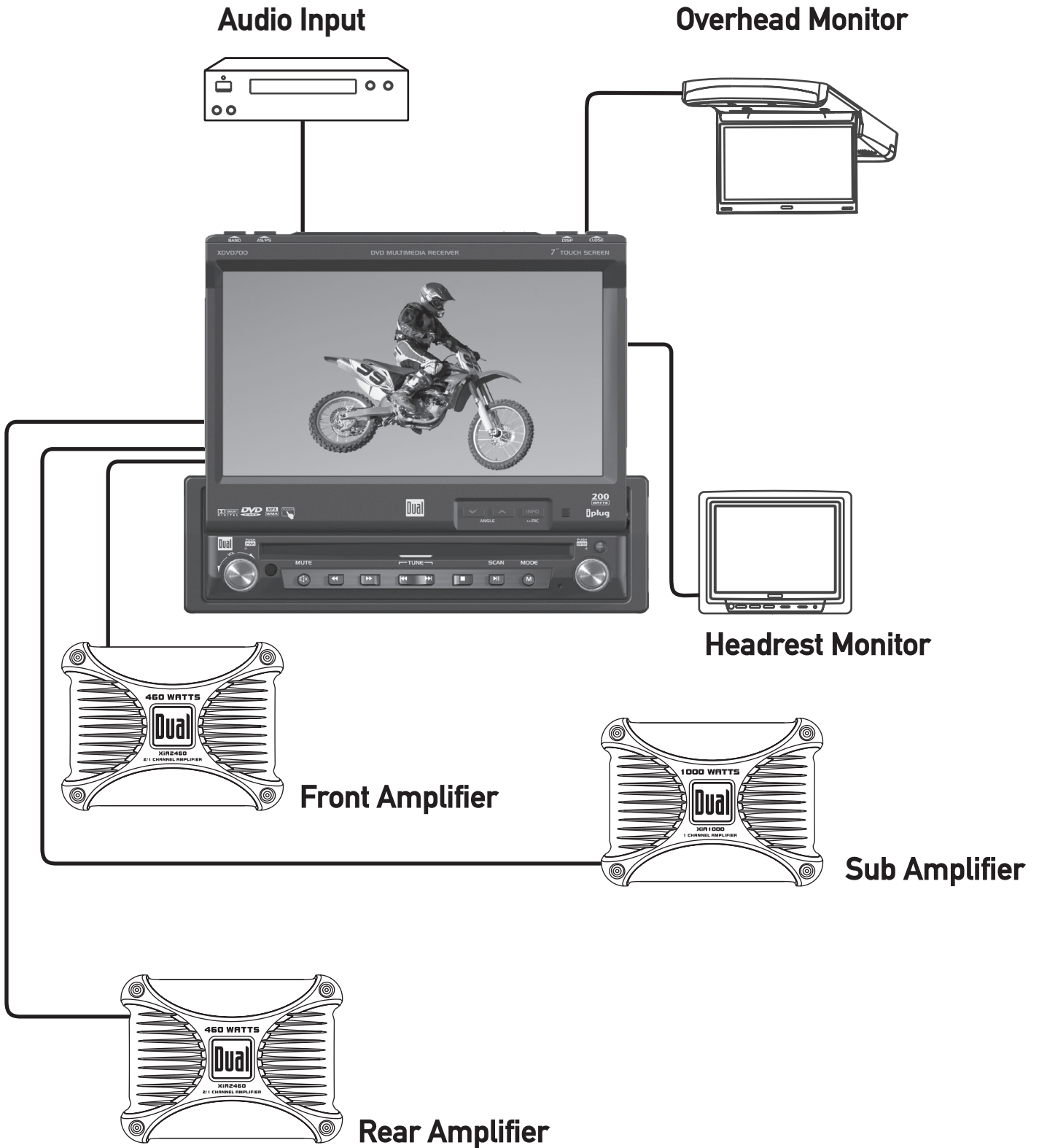

IR Remote Preparation

To first use the IR Remote control, you must first pull the battery insulation tape out

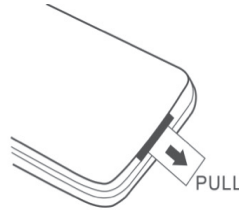

Notes:

- Remove the battery if the remote will not be used for a month or longer
- Remove and dispose of battery properly

Insert or replacing the Battery:

Remove the battery holder

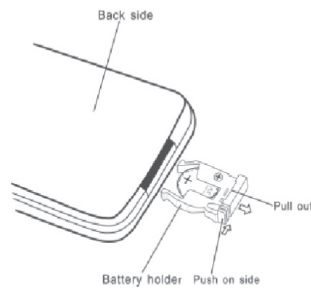

Remove the battery from the battery holder

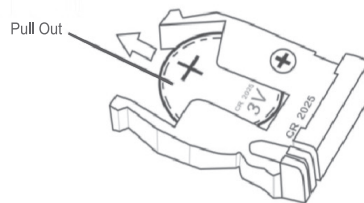

Install the new battery
Make sure to keep the (+) side up

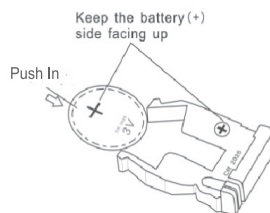

Insert the battery holder

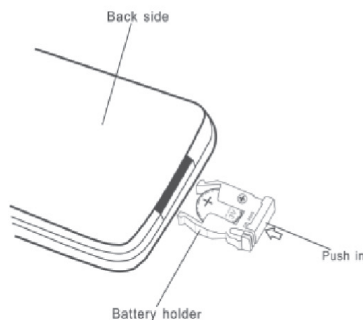

CAUTION!!!

- Do not store battery with metallic objects or materials

Control Locations - Monitor Closed

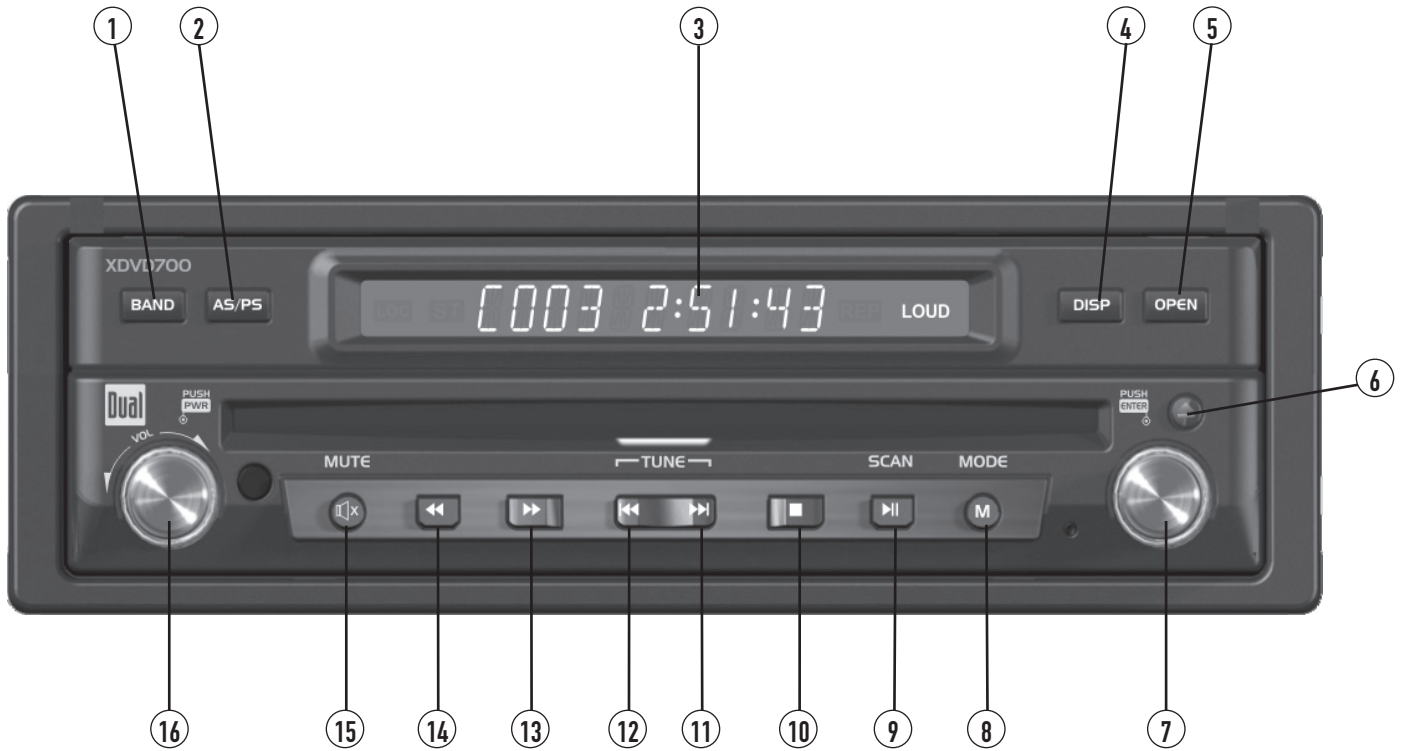

- | | |
|--------------------------|----------------------|
| ① Band | ⑨ Play/Pause/Scan |
| ② Auto Store/Preset Scan | ⑩ Stop |
| ③ Secondary LCD | ⑪ Chapter/Track Up |
| ④ Display | ⑫ Chapter/Track Down |
| ⑤ Open/Close Monitor | ⑬ Fast Forward |
| ⑥ Eject | ⑭ Fast Reverse |
| ⑦ Rotary Encoder/Enter | ⑮ Mute |
| ⑧ Mode | ⑯ Power/Volume |

Monitor Notes:

- This model incorporates a motorized moving monitor. Before final installation, make sure the monitor will not obstruct the dash, shifter or any other controls.
- Upon installation, do not attempt to move the monitor up/down by hand. Use the **ANGLE ▲/▼** and **OPEN** buttons on the front panel only.
- The unit will stop if it encounters any obstacles during the open/close sequence. If this occurs, remove the obstacle and press **OPEN** again to resume the monitor open/close sequence.

Control Functions - Monitor Closed

BAND	Press BAND to increment from FM1, FM2, FM3, AM ⇒ FM1. The FM band indicator is shown as "1", "2" or "3" and is located on the far left side of the secondary LCD. The AM band indicator is shown as "A".
AS/PS (Auto Store /Preset Scan)	Press AS/PS momentarily to start station PRESET SCAN function, Press AS/PS for 2 seconds to start AUTO STORE station preset function in current BAND .
SECONDARY LCD	Additional LCD for system information while monitor is closed.
DISP	Press the DISP button to display various information on the secondary LCD .
OPEN	Press OPEN to open or close the monitor. The unit will emit a confirmation beep upon opening or closing. Be careful not to touch or obstruct the monitor movement during the open/close sequence, or permanent damage could occur.
EJECT	Press once to eject disc.
RIGHT ROTARY	Rotate clockwise/counter-clockwise to select desired item and press once to ENTER .
MODE	Press once to incrementally select desired source.
TRACK/SEEK UP	Selects the next chapter/track/radio station.
TRACK/SEEK DOWN	Selects the previous chapter/track/radio station.
STOP	Stop playback of DVD/CD/MP3.
PLAY/PAUSE	Press once for PAUSE , press again for PLAY .
FAST FORWARD/TUNE UP	Fast forwards the chapter/track or selects the next radio frequency.
FAST REVERSE/TUNE DOWN	Fast reverses the chapter/track or selects the previous frequency.
MUTE	Press once to MUTE audio, MUTE will appear in the secondary LCD. Press again to return audio.
POWER ON/OFF	Press POWER momentarily to turn the unit on. Press and hold POWER for more than 2 seconds to turn the unit off. Note: EJECT will still function even if POWER is off.
VOLUME	Rotate clockwise/counter clockwise for desired VOLUME level.

Control Locations - Monitor Open



- ① Disc-in indicator - Red = Disc inserted, White = No disc.
- ② ANGLE ▼ - Press to decrease the monitor view angle.
- ③ ANGLE ▲ - Press to increase the monitor view angle.
- ④ INFO - Press to display DVD INFO. Press and hold to access the Picture Menu and adjust the **CONTRAST** and **BRIGHTNESS**.
- ⑤ Press to **RESET** system.

Safety Notes:

The DVD video display of the in-dash unit will not operate while the vehicle is moving. This is a safety feature to prevent driver distraction. In-dash DVD video functions will only operate when vehicle is in Park and the parking brake is engaged. It is illegal in most states for the driver to view video while the vehicle is in motion.

Control Functions - Monitor Open

Disc-in indicator

White = No disc
Red = Disc inserted

Monitor Angle ▲▼

Press **ANGLE ▲** to increase the monitor view angle.

Press **ANGLE ▼** to decrease the monitor view angle.

Notes:

- Do not attempt to move the monitor up/down by hand - severe damage will occur. Use the front panel buttons or the remote control only.
- The color of the LCD monitor varies between viewing angles. Select the angle with the most optimum view for your location.
- The last position of the monitor will be saved in memory. The monitor will return to its last position automatically the next time it is opened.

INFO/PIC

Press **INFO** for 1 second to display DVD disc information.

Press and hold **INFO** for 2 seconds to access the Picture Menu and adjust the **CONTRAST** and TFT LCD **BRIGHTNESS**.

Press **ANGLE ▲** to increase, **ANGLE ▼** to decrease or use **VOLUME** rotary to adjust the levels up or down.

SYSTEM RESET

If you experience abnormal operation or, your unit is inoperable, press the **RESET** button for 3 seconds, located on the front bottom-right corner of the unit. After a system reset, the unit restores some of the factory default settings.

Note: Use the tip of a pen to access the button.



System Reset

Control Locations - Remote

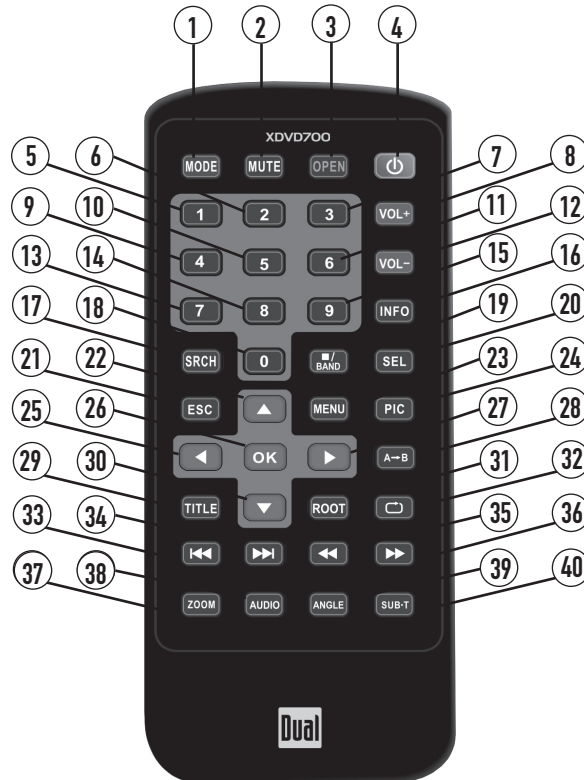

- | | | |
|--------------|---------------|---------------------------------|
| ① Mode | ⑩ Key #5 | ⑲ Band/Stop |
| ② Mute | ⑪ Key #6 | ⑳ Audio Select |
| ③ Open/Close | ⑫ Volume Down | ㉑ Escape |
| ④ Power | ⑬ Key #7 | ㉒ 4-Way - Up |
| ⑤ Key #1 | ⑭ Key #8 | ㉓ Menu |
| ⑥ Key #2 | ⑮ Key #9 | ㉔ Picture |
| ⑦ Key #3 | | ㉕ 4-Way - Left |
| ⑧ Volume Up | | ㉖ OK |
| ⑨ Key #4 | | ㉗ 4-Way - Right |
| | | ㉘ Repeat A-B |
| | | ㉙ Title Menu |
| | | ㉚ 4-Way - Down |
| | | ㉛ Root |
| | | ㉜ Repeat |
| | | ㉝ Chapter/Track/Seek Down |
| | | ㉞ Chapter/Track/Seek Up |
| | | ㉟ Fast Reverse/Manual Tune Down |
| | | ㊱ Fast Reverse/Manual Tune Up |
| | | ㊲ Zoom |
| | | ㊳ Audio |
| | | ㊴ Angle |
| | | ㊵ Sub-Title |

* The remote control uses one 3 volt Lithium CR2025 battery. For best performance, replace only with CR2025 or equivalent.

Control Functions - Remote

Mode	Press once to incrementally select desired source.
Mute	Press once to MUTE audio, press again to return audio.
Open/Close	Press once to open monitor, press again to close the monitor.
Power	Press once to turn the unit on, press again to turn unit off.
Keys 0-9	Direct access chapter/track/preset station for current BAND .
Volume Up	Increase VOLUME .
Volume Down	Decrease VOLUME .
Info	Displays DVD information.
Search	Search function in the DVD/CD disc mode.
Band / Stop	Press to increment BAND , or STOP while in DVD/MP3 mode.
Audio Select	Enter AUDIO Setup mode.
Escape	Exit current menu.
4-Way -Up/Down/Left/Right	Navigating system and DVD menus.
Menu	Enter the MAIN system menu.
Picture	Adjust CONTRAST and BRIGHTNESS parameters for TFT.
OK	Starts/pauses playback or confirm settings.
Repeat A-B	Repeat playback from time frame A to time frame B.
Title Menu	Enters the title menu on DVD.
Root	Enters the main menu of the DVD.
Repeat	Repeats playback of current chapter/track or folder.
Chapter/Track Down	Selects the previous chapter/track for playback.
Chapter/Track Up	Selects the next chapter/track for playback.
Fast Rewind	Fast reverses the disc content.
Fast Forward	Fast forwards the disc content.
Zoom	Zooming in/out on an image from DVD disc.
Audio	Change the audio language for DVD disc playback.
Angle	Plays DVD disc in different angle for a scene.
Sub-Title	Language selection for subtitle.



General Operation

Power On/Off	<p>Press POWER momentarily to turn the unit on, the unit will beep. Press and hold POWER for more than 2 seconds to turn the unit off.</p> <p>Note: EJECT will still function even if POWER is off.</p>
Monitor Open/Close	<p>Press OPEN to open or close the monitor. The unit will emit a confirmation beep upon opening or closing. Be careful not to touch or obstruct the monitor movement during the open/close sequence.</p> <p>Notes:</p> <ul style="list-style-type: none">• The unit will stop automatically during open/close if an obstacle is detected. If this occurs, remove the obstacle and press OPEN again to resume the monitor open/close sequence.• Audio can be heard while the monitor is closed.
Monitor Angle Position	<p>Press ANGLE ▲ to increase the monitor view angle. Press ANGLE ▼ to decrease the monitor view angle.</p> <p>Notes:</p> <ul style="list-style-type: none">• Do not attempt to move the monitor up/down by hand - severe damage will occur. Use the front panel buttons or the remote control only.• The color of the LCD monitor varies between viewing angles. Select the angle with the most optimum view for your location.• The last position of the monitor can be saved in memory. The monitor will return to its last position automatically the next time it is opened. <p>Notes:</p> <ul style="list-style-type: none">• The vehicle must be in park and the parking brake applied to view video on the in-dash monitor.• As a safety feature, a blue "CAUTION" screen will show on the display when the vehicle's parking brake is not engaged. DVD, AUX IN audio can be heard while the vehicle is in motion.• The video display of the in-dash unit will not operate while the vehicle is moving. This is a safety feature to prevent driver distraction. In-dash video functions will only operate when vehicle is in Park and the parking brake is engaged. It is illegal in most states for the driver to view video while the vehicle is in motion. Refer to local laws in your area. <p>See DVD operation on page 34 for more details on how to initialize the PARKING BRAKE.</p>

General Operation

- Mode** Press **MODE** to select between **TUNER**, **DVD** and **AUX IN** inputs. Modes of operation are indicated in the **OSD** (On Screen Display) and secondary **LCD**.
- Optional Mode Selection** With the monitor open, press the top left corner of the screen to display the **OSD** menu. Press **TUNER**, **DVD** or **AUX IN** icon to select the desired source.
- Volume** Adjust **VOLUME** using rotary encoder or the **VOL ▲ ▼** buttons.
- Programmable Turn-on Volume** Turn **VOLUME** rotary to desired listening level, press and hold **VOLUME** rotary knob for 3 seconds to program currently selected volume level.
- Mute** Press **MUTE** to silence the audio; will appear in the **OSD**. Press **MUTE** again to cancel.
- Audio Adjustment (from front panel)** Press in **VOLUME** rotary knob on left front panel, Press in **VOLUME** again to advance to desired parameter to be changed, Turn **VOLUME** rotary ⤴ or ⤵ to adjust to desired level, Press in **VOLUME** to advance to next selection, Press and hold the **VOLUME** button on the front panel to exit.



ITEM	RANGE	
	USER	FLAT
EQ	JAZZ	POP
	CLASSICAL	ROCK
	NEWS	URBAN
	RAVE	MOVIE
	TECHNO	
BASS	-7	+7
TREBLE	-7	+7
BALANCE	-9	+9
FADER	-9	+9
SUB	-7	+7
LOUD	OFF	ON

- Audio Adjustment (from Remote)** Press the **SEL** button, Press the **▲ ▼** buttons on the remote to select an item to be adjusted, Press **◀ ▶** to adjust the desired setting, Press the **ESC** button on the remote control to exit the audio control menu.

Notes: The Bass and Treble levels are only adjustable when EQ is set to "User" mode. The Loud function compensates for deficiencies in sound ranges at low levels. When the Loud function is on, LOUD is displayed on the screen.



General Operation

INFO/PIC	Press INFO button for 1 second to display DVD disc information.
BRIGHTNESS/CONTRAST	Press and hold INFO for 2 seconds to access the Picture Menu and adjust the CONTRAST and TFT LCD BRIGHTNESS . Press ANGLE ▲ to increase, ANGLE ▼ to decrease or use VOLUME rotary to adjust the levels up or down.
BAND	Press BAND to increment from FM1, FM2, FM3, AM ⇒ FM1.
AS/PS (Auto Store /Preset Scan)	Press AS/PS momentarily to start station PRESET SCAN function. The unit will now scan your program presets for 10 seconds for each preset in that band. Press AS/PS again to stop scanning. Press AS/PS for 2 seconds to start AUTO STORE station preset function in current BAND .
DISP	Press the DISP button to display various information on the secondary LCD screen when the monitor is closed.
EJECT	Press once for DISC ejection.
RIGHT ROTARY	Press to access MAIN menu, rotate clockwise/counter-clockwise to select desired item and press once to ENTER .
MODE	Press once to incrementally select desired source.
TRACK/SEEK UP	Selects the next chapter/track/radio station.
TRACK/SEEK DOWN	Selects the previous chapter/track/radio station.
STOP	Stop playback of DVD/CD/MP3 .
PLAY/PAUSE	Press once for PAUSE , press again for PLAY .
FAST FORWARD/TUNE UP	Fast forwards the chapter/track or selects the next radio frequency.
FAST REVERSE/TUNE DOWN	Fast reverses the chapter/track or selects the previous frequency.
SECONDARY LCD	Secondary LCD displays the following information (only when monitor is closed): LOC - LOCAL indicator; icon will be off when DISTANCE (DX) is selected. ST - STEREO radio station indicator. INFO - Displays TRACK time, TUNING frequency, MP3 ID3 info, & CLOCK , etc. LOUD - LOUDNESS selection indicator.

General Operation

Main Menu Access

There are three methods to access the MAIN menu:

- Press the ENTER button on the right ROTARY knob.
- Press the MENU button on the remote control.
- Touch the upper left corner of the touch screen.

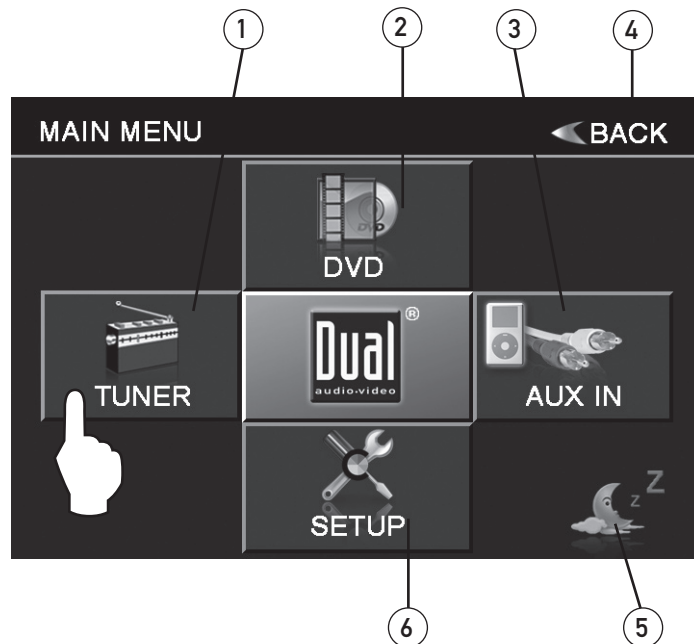

Touch Access Buttons

- 1) Touch to access **AM/FM TUNER** mode.
- 2) Touch to access **CD/DVD** mode. (CD/DVD must be inserted).
- 3) Touch to access **AUX INPUT** mode.
- 4) Touch to go **BACK** to previous screen.
- 5) Touch to **STANDBY** screen, touch screen again or any button to resume display.
Note: VOLUME level can be controlled in **STANDBY** mode.
- 6) Touch to access **SETUP** menu.

Rapid Dial Rotary Encoder

The rotary encoder can also control touch screen functions from the main menu.

- Select desired function rotating clockwise or counter-clockwise.
- Function will be outlined in yellow.
- Press to confirm/ENTER.

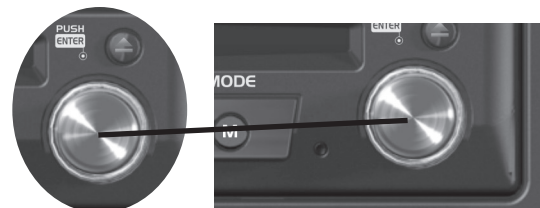

General Setup Menu

General Setup Menu

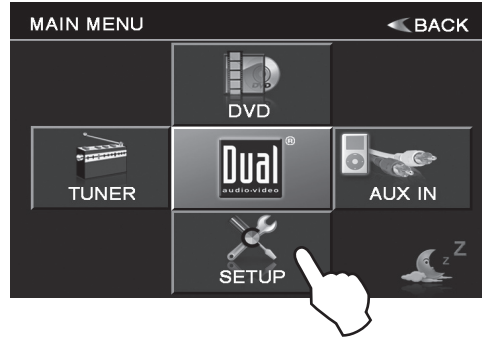

- Upon entering **Setup Menu**, the **General** tab is the default display.
- Select desired parameter to change.
- Page will return back to previous screen after 10 seconds of inactivity or by pressing the **BACK** button.

Note: Default anti-theft password is 0000.

General Setup Menu Matrix

Settings	Default	Options	Function
Radio	USA	USA	Set to appropriate setting for your country
		S-Amer1	
		S-Amer2	
		Europe	
Video Out	Disable	Disable	Disables video out function
		Enable	Enables video out function
TFT Auto Open	Off	On	TFT panel will automatically open when IGN is turned on
		Off	TFT panel will not auto open when IGN is turned on
		Manual	TFT will only open/close when OPEN button is pressed
Clock Mode	12Hr	12Hr	PM 6:00
		24Hr	18:00
Clock	AM	00:00	See CLOCK ADJUST on page 21 for more details
Anti-Theft Code	0000	----	Must enter password to turn anti-theft on or off
Anti-Theft	Off	On	System will require a password if main battery power is removed for more than 5 minutes
		Off	No password will be required if power is removed
Load Factory	No	Are you sure? No/Yes	Load all factory parameters to their original settling Note: This will not reset the anti-theft password Default anti-theft password is 0000.

General Setup Menu

Select Radio Region

From the **General Setup Menu**, press **Radio**. Touch the setting for your region.

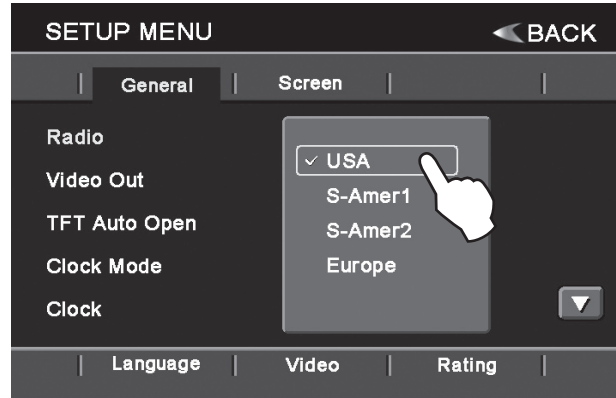

Video Out

From the **General Setup Menu**, press **Video Out**. Touch the desired setting (Disable or Enable).

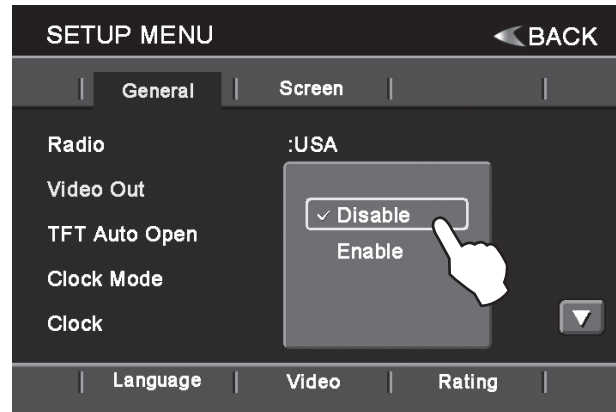

TFT Auto Open

From the **General Setup Menu**, press **TFT Auto Open**. Touch the desired setting to determine if the TFT panel will open automatically or manually.

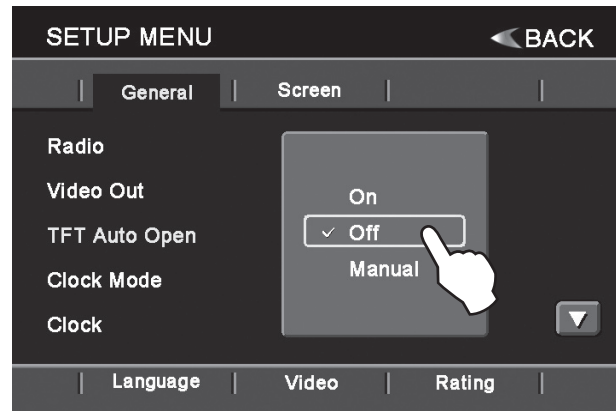

General Setup Menu

Clock Mode

From the **General Setup Menu**, press **Clock Mode**. Touch the desired setting to choose a 12-hour or 24-hour clock display.

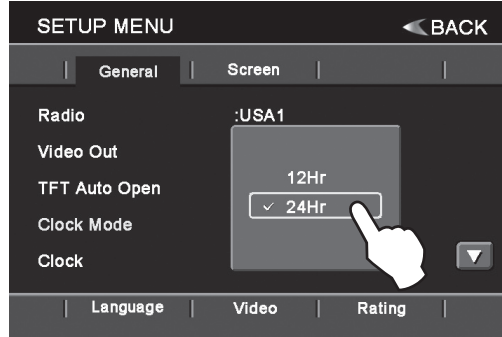

Clock Adjust

From the **General Setup Menu**, press the current time on the **Clock** line, and a keypad will appear. Enter two numbers for the hour and two numbers for the minute. For example, 8:05 would be entered "0805". Press OK to confirm, then press **AM** or **PM** to select the AM or PM designation.

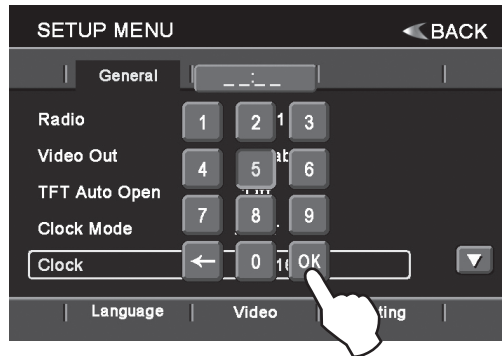

Anti-theft Code

Note: By default Anti-theft password is 0000 and is turned Off. To turn this feature on, follow the steps below. This feature will lock the unit from operating if battery power is disconnected for more than 5 minutes.

From page 2 of the **General Setup Menu**, press "----" and a keypad will appear. Enter "0000", then press OK. The Anti-Theft On/Off feature will unlock, allowing adjustment of this option.

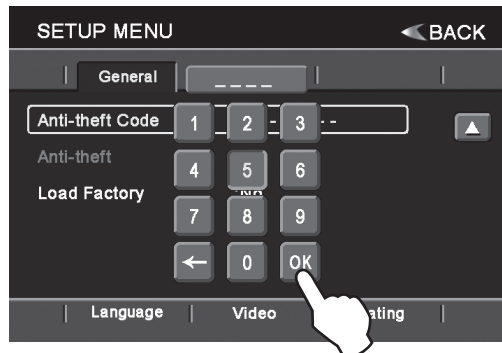

General Setup Menu

Anti-theft On/Off

From the **General Setup Menu**, press **Anti-Theft**. Press **On** to activate this feature.

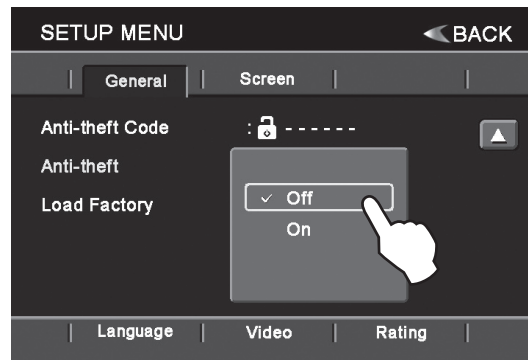

Note: Choose a personal 4-digit password for the unit. Write it down, and keep it in a safe location.

To change the password, the Anti-Theft feature must be activated as described above. Once Anti-Theft is set to on, press "----". When the keypad appears, enter the new four-digit code and press **OK**.

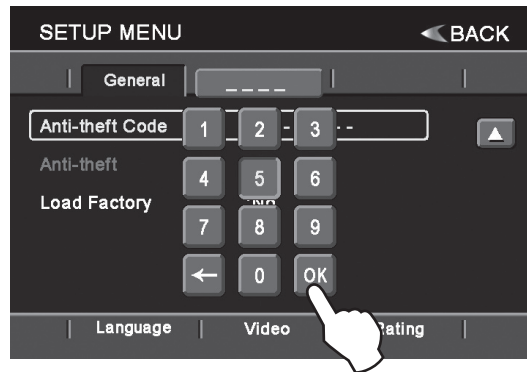

Load Factory

From the **General Setup Menu**, press **Load Factory**. Press **YES** to load all factory parameters to their original settings. The unit will prompt for confirmation before reloading the factory settings.

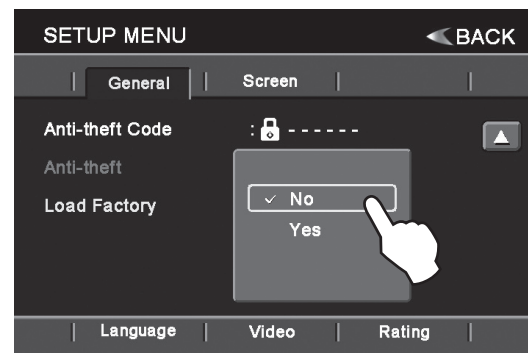

Screen Setup Menu

Screen Setup Menu

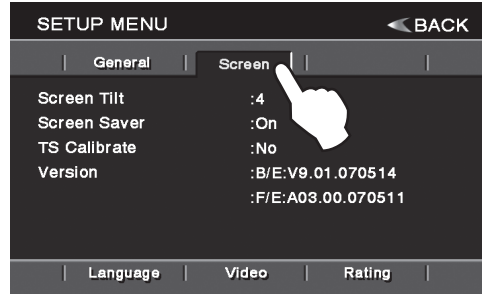

- Press the **Screen** tab to access **Screen Setup Menu**.
- Select desired parameter to change.
- Page will return back to previous screen after 10 seconds of inactivity or by pressing the **BACK** button.

Screen Setup Menu Matrix

Settings	Default	Options	Function
Screen Tilt	4	1 - 5	Select 1 to 5 to adjust the default tilt angle of the screen
Screen Saver	On	Off	Select On to activate the screen saver and Off to deactivate
		On	
TS Calibrate	No	No	Touch Yes to enter the Touch Screen Calibration Mode
		Yes	
Version			Displays the software version of unit

Screen Tilt

From the **Screen Setup Menu**, press **Screen Tilt**. Touch the desired setting (1-5) to adjust the default tilt angle of the screen.

Note: Tilt settings 1-4 are displayed on the first screen of the sub-menu. Scroll down to display tilt setting 5.

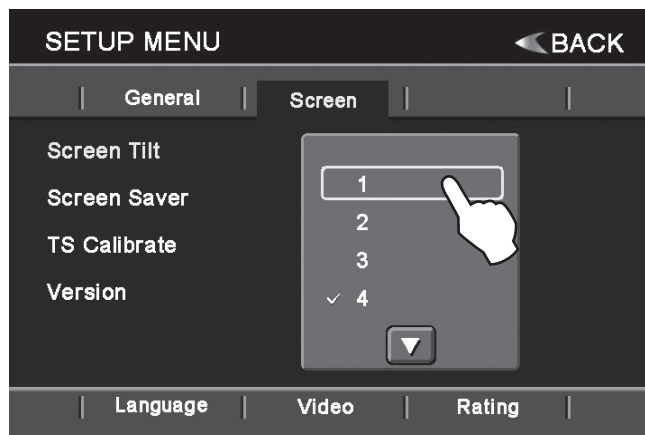

Screen Setup Menu

Screen Saver

From the **Screen Setup Menu**, press **Screen Saver**. Touch **On** to activate the screen saver or **Off** to deactivate it.

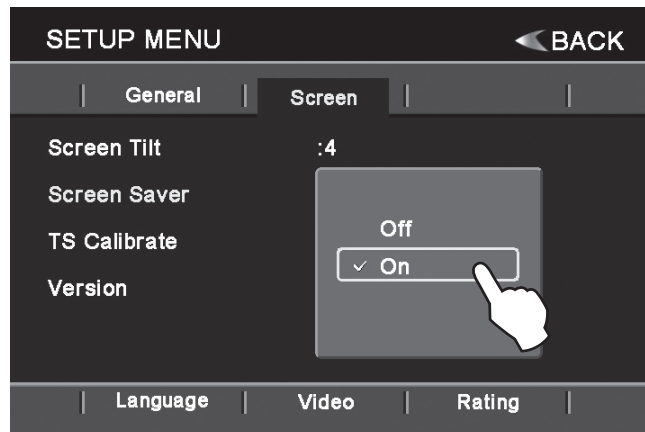

Touch Screen Calibrate

From the **Screen Setup Menu**, press **TS Calibrate**. Touch **Yes** to enter **Touch Screen Calibration Mode**. Follow the on-screen prompts to calibrate.

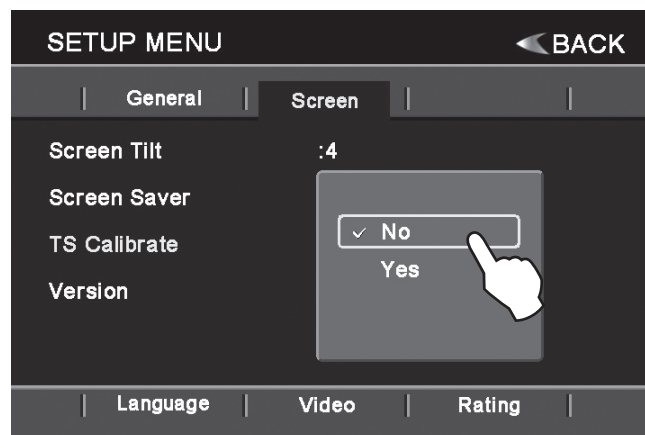

Note: For proper calibration you must touch each pointer for 2 seconds. If pointers are not touched properly, the calibration sequence will start over until the calibration is done correctly.

Version

Displays the current version number of the software.

Language Setup Menu

Language Setup Menu



- Press the **Language** tab to access **Language Setup Menu**.
- Select desired parameter to change.
- Page will return back to previous screen after 10 seconds of inactivity or by pressing the **BACK** button.

Language Setup Menu Matrix

Settings	Default	Options	Function
Subtitle	Off	English, French, Spanish, Auto, Off	Select desired disc subtitle language
Audio	English	English, French, Spanish	Select desired disc audio language
DVD menu	English	English, French, Spanish	Select desired disc menu language

Disc Subtitle

From the **Language Setup Menu**, press **Subtitle**. Select the desired language for subtitle display.

Note: Options **English, French, Spanish and Auto** are displayed on the first screen of the sub-menu. Press the down arrow to display **Off** option.

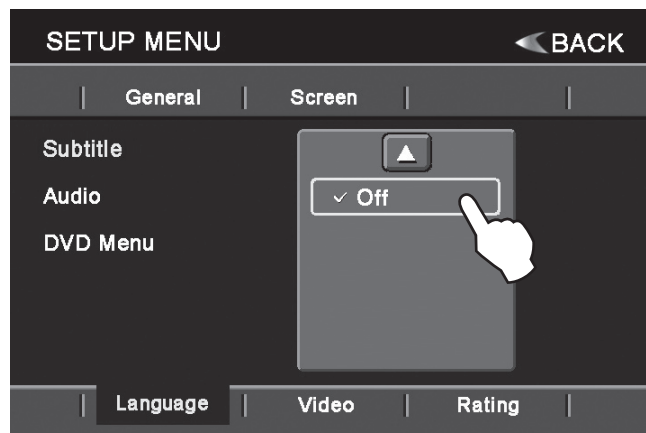

Language Setup Menu

Audio Language

From the **Language Setup Menu**, press **Audio**. Select the desired disc audio language.



DVD Menu

From the **Language Setup Menu**, press **DVD menu**. Select the desired disc menu language.

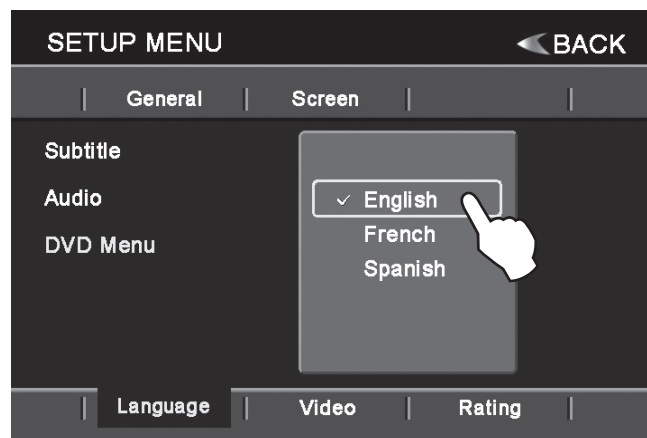

Video Setup Menu

Video Setup Menu

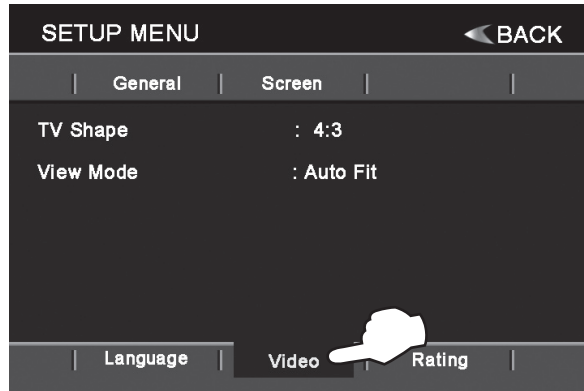

- Press the **Video** tab to access **Video Setup Menu**.
- Select desired parameter to change.
- Page will return back to previous screen after 10 seconds of inactivity or by pressing the **BACK** button.

TV Shape

From the **Video Setup Menu**, press **TV Shape** to select 4:3 or 16:9.

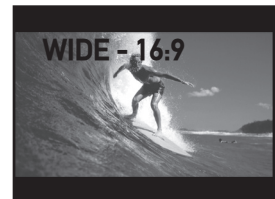
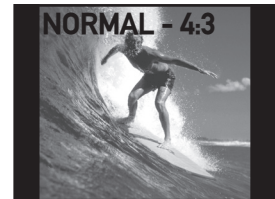
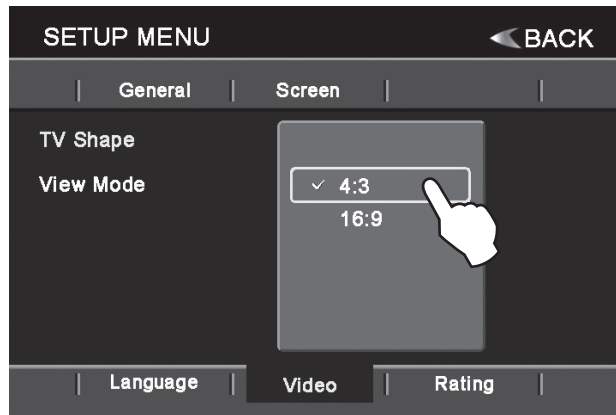

View Mode

From the **Video Setup Menu**, press **View Mode**. Select desired view mode: **Fill**, **Original**, **Auto Fit** or **Pan Scan**.

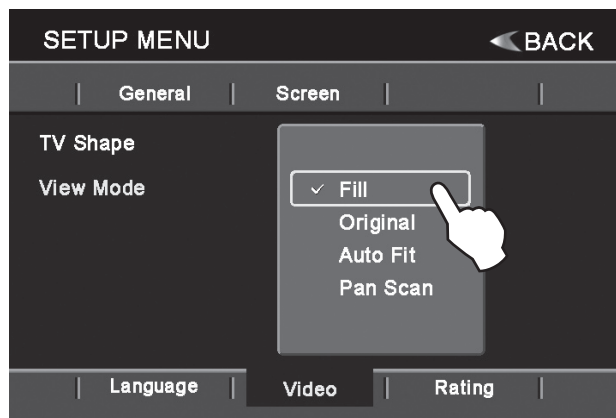

Rating Setup Menu

Rating Setup Menu

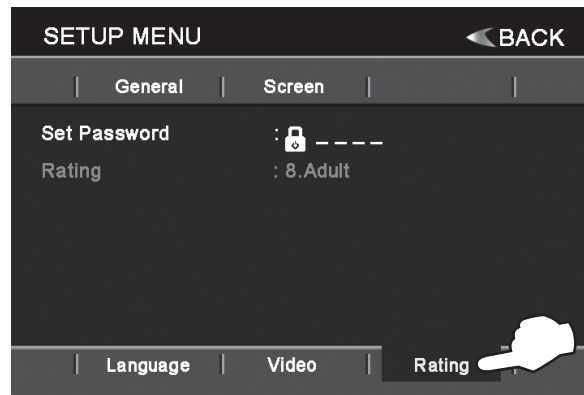

- Press the **Rating** tab to access **Rating Setup Menu**.
- Select desired parameter to change.
- Page will return back to previous screen after 10 seconds of inactivity or by pressing the **BACK** button.

Set Password

From the **Rating Setup Menu**, press "----" to enter a password. Enter the password to adjust the rating level. The default rating password is 9991.

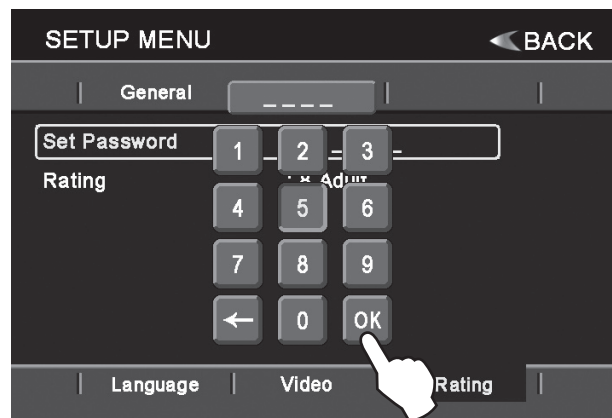

Set Rating Level

From the **Rating Setup Menu**, press **Rating** to select the desired rating level. The unlock icon must appear beside "----" to adjust the rating level.

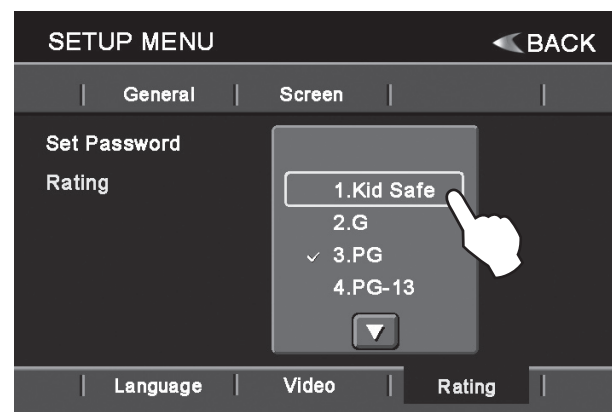

AM/FM Tuner Operation - OSD Overview



- | Tuner Mode | Description |
|------------|---|
| 1) | Current Source Indicator
Displays source currently playing. |
| 2) | Tune Frequency - Down
Touching this icon will tune the radio to a lower frequency by one frequency step. Touch and hold to continuously tune down. |
| 3) | Band
Touch band icon repeatedly until the desired band is displayed, FM-1, FM-2, FM-3, or AM. (This function can also be performed by pressing the BAND button.) |
| 4) | Tune Frequency - Up
Touching this icon will tune the radio to a higher frequency by one frequency step. Touch and hold to continuously tune up. |
| 5) | Seek Next Station - Up
Touching this icon will tune to the next strong station at a higher frequency. |
| 6) | Stereo Indicator
Shows that the frequency selected is received in stereo. |
| 7) | Current Station/Band Indicator
Indicates current frequency and band. |



AM/FM Tuner Operation - OSD Overview

- 8) Clock
Indicates current time.
- 9) Loudness Indicator
Indicates loudness setting.
- 10) EQ Indicator
Indicates current EQ preset.
- 11) Current Station Indicator
Indicates current frequency.
- 12) Display
Press to select between standard display and preset view.
- 13) Local / DX Tuning Mode
Shows when local or distance tuning is on.
- 14) Direct Preset Tuning
Press to display keyboard and access presets by number. For example, press "2" and "OK" to listen to preset 2.
- 15) Auxiliary Input Mode
Touching this icon will select Auxiliary Input mode.
- 16) DVD Mode
Touching this icon will select DVD mode (if a disc is loaded).
- 17) Tuner Scan
Touching this icon will scan through all available stations in the current band.
- 18) Preset Scan
Touching this icon will scan through all presets in the current band. (This function can also be performed by pressing the **AS/PS** button.)
- 19) Auto Station Tune
Holding this button for more than 2 seconds will automatically program the 12 strongest stations available into the presets in the current band. (This function can also be performed by holding the **AS/PS** button.)
- 20) Volume Indicator
Indicates current volume level, controlled by rotary encoder.
- 21) Band Indicator
Shows which band the radio is tuned to, FM-1, FM-2, FM-3, or AM.
- 22) Seek Next Station - Down
Touching this icon will tune to the next strong station at a lower frequency.

AM/FM Tuner Operation



AM/FM Tuner Mode	From the main menu, touch TUNER icon to select AM/FM Tuner mode.
	From the remote control or the front panel: Press MODE until TUNER is displayed on the screen.
Band	Touch Ⓜ on the screen repeatedly until the desired band is displayed, FM-1, FM-2, FM-3, or AM. Press the BAND button to switch between bands, FM-1, FM-2, FM-3, AM.
	From the remote control: Press the BAND button.
Manual Tuning	Touch ▶▶ on the screen to tune to the next higher frequency step. Touch ◀◀ on the screen to tune to the next lower frequency step. Touch and hold either ◀◀ or ▶▶ on the screen to continue tuning across multiple stations. From the remote control: Touch ◀◀ or ▶▶ to perform manual tuning.
Seek Tuning	Touch ▶▶▶ on screen to tune to the next higher strong station. Touch ◀◀◀ on screen to tune to the next lower strong station. Press ▶▶▶ on front panel to tune to the next higher strong station. Press ◀◀◀ on front panel to tune to the next lower strong station. From the remote control: Press ▶▶▶ or ▶ to tune to the next higher strong station. Press ◀◀◀ or ◀ to tune to the next lower strong station.
Preset Scan	Touching the PS button will scan through all presets in the current band and play them for 10 seconds each. Press the AS/PS button momentarily.
Scan Tuning	Touch SCAN on the screen and it will tune you to all stations available with good reception for 10 seconds at a time. Touch SCAN again to disable.
Local Tuning	Local tuning lets you tune in radio stations with sufficiently strong signals for good reception. In areas that reception is poor, you can switch from local to distance tuning by touching the DX/LOC button on the screen.



AM/FM Tuner Operation

Tuner Mode
Preset View



Access Preset View

Press **DISP** to select between standard display and preset view.

Direct Preset Tuning

To select a desired station from the preset station list, touch any of the displayed station frequencies from the list.

Use Rapid Dial by turning the right rotary clockwise or counter-clockwise, and pressing in to select the highlighted channel.

Use the up and down arrows on screen to scroll between the preset pages. Once highlighted, simply touch the screen at the appropriate preset.

From the remote control:

Press **▲** or **▼** to scroll through the presets. When the correct preset is highlighted press **OK**.

Use the numeric keypad to enter the desired preset number.

Storing Presets

There are 36 FM and 12 AM presets available in 4 bands.

After finding a frequency that you would like to store in memory, touch and hold the screen on any of the frequencies in the preset station list until it turns yellow.

Auto Store Presets

Touch and hold the **AS** icon to automatically program the 12 strongest stations available into the presets in the current band.

Press the **AS/PS** button for more than 2 seconds.



XDVD700 OPERATION

⚠ WARNING ⚠

Upon installation of this Monitor/DVD player (“unit”) into a vehicle, the driver of the vehicle must not operate this unit by watching videos or playing video games while driving. Failure to follow this instruction could lead to driver distraction which could result in serious injury or death to the vehicle’s occupants or persons outside the vehicle and/or property damage.

Several states prohibit the installation of monitors/DVD players if the screen is visible from the driver’s seat. If you reside in a jurisdiction which has enacted such a law, this unit must not be installed so that the screen is visible from the driver’s seat. When installing this unit in the front console/dashboard, the unit must be positioned so that it is facing the front passenger seat only. Failure to follow this instruction could lead to driver distraction which could result in serious injury or death to the vehicle’s occupants or persons outside the vehicle and/or property damage.

This unit is designed so that it may be operated only when the vehicle is in “Park” and the parking brake is fully engaged. To this end, this unit includes a parking brake lock-out feature which prohibits the unit from operating if the vehicle is not in “Park” and/or the parking brake is not fully engaged. When installing this unit, the installer must connect the parking brake detect wire (“Yellow-Blue Lead”) to the parking brake mechanism in order to make the parking brake lock-out feature operable. **DO NOT** simply ground the parking brake detect wire to a metal portion of the vehicle. Failure to properly install the parking brake lock-out feature could lead to driver distraction which could result in serious injury or death to the driver’s occupants or persons outside the vehicle and/or property damage.

Once the parking brake lock-out feature is installed, the owner/user must not attempt to disrupt/neutralize the parking brake lock-out feature by (a) partially engaging the parking brake and/or (b) purchasing/using any device or unit designed to send necessary brake signals to the unit. Failure to follow these instructions could lead to driver distraction which could result in serious injury or death to the driver’s occupants or persons outside the vehicle and/or property damage.

When operating this unit, keep the unit’s volume level low enough so that the vehicle’s occupants can hear traffic-related sounds such as police and emergency vehicles. Failure to follow this instruction could lead to driver distraction which could result in serious injury or death to the vehicle’s occupants or persons outside the vehicle and/or property damage.

DVD Operation - Parking Brake Initialization



CAUTION!

It's Unlawful To Operate
A Vehicle While Video is
Displayed in The Drivers
Viewing Area

Engage Emergency Brake
To Enjoy Video

SAFETY WARNING



- The video display of the in-dash unit will not operate while the vehicle is moving. This is a safety feature to prevent driver distraction. In-dash video functions will only operate when vehicle is in Park and the **PARKING BRAKE** is engaged. It is illegal in most states for the driver to view video while the vehicle is in motion. Refer to local laws in your area.
- Audio can be heard while the monitor is closed.
- The vehicle must be in park and the parking brake applied to view video on the in-dash monitor.
- As a safety feature, "ENGAGE PARKING BRAKE" blue screen will show on the display when the vehicle's parking brake is not engaged. Video display on the front monitor isn't allowed until the **PARKING BRAKE** is engaged. By connecting the yellow/blue **PARKING BRAKE** wire to brake switch circuit as described below, DVD and AUX IN audio can be heard while the vehicle is in motion without engaging the parking brake.

Front TFT Video Initialization

Follow these two initialization procedures carefully to allow video playback on XDVD700 front panel TFT:

There are two situations that start the **PARKING BRAKE** sequence.

Parking Brake Initialization Situation 1

First situation is while driving:

- 1) Stop vehicle, put in Park, make sure **PARKING BRAKE** is off/released
- 2) Depress **PARKING BRAKE** for 1 second
- 3) Release **PARKING BRAKE** for 1 second
- 4) Depress **PARKING BRAKE** permanently

Note:

Once above procedure 1-4 is completed, video will display in approximately 6 seconds.

Parking Brake Initialization Situation 2

Second situation is while already parked and the **PARKING BRAKE** is already applied:

- 1) Keep vehicle in Park, **PARKING BRAKE** should be on
- 2) Release **PARKING BRAKE** for 1 second
- 3) Depress **PARKING BRAKE** for 1 second
- 4) Release **PARKING BRAKE** for 1 second
- 5) Depress **PARKING BRAKE** permanently

Notes:

Once 2nd procedure 1-5 is completed, video will display in approximately 6 seconds. The transition time must be less than 2 seconds between depress and release. This procedure will have to repeated if the IGN is turned off.



XDVD700 OPERATION

DVD Operation



DVD Region Management

Some DVD discs can be played only in certain playback modes according to the intentions of the software. As the XDVD700 plays discs according to their intentions, some functions may not work as intended. Please be sure to read the instructions provided with each disc. This player has been designed to play back DVD software that has been encoded for specific region areas. It cannot play back DVD software encoded for other region areas than the region areas for which it has been designed.

The XDVD700 will play discs labeled "Region 1" or "All".

DVD region codes:

- 1 - USA, Canada
- 2 - Japan, Europe, South Africa, Middle East
- 3 - Rep. of Korea, Taiwan, Hong Kong, Parts of Southeast Asia
- 4 - Australia, New Zealand, Mexico, South America
- 5 - Eastern Europe, Russia, India, Africa
- 6 - China



DVD Disc Symbols

Symbol	12cm Disc Properties	Max Play Time
	Single side single layer (DVD-5) Single side double layer (DVD-9) Double side single layer (DVD-10) Double side double layer (DVD-18)	(MPEG 2 Method) 133 minutes 242 minutes 266 minutes 484 minutes
	Single side single layer (VCD)	(MPEG 1 Method) 74 minutes
	Single side single layer	74 minutes

Symbol	Meaning
	Number of voice languages recorded. The number inside the icon indicates the number languages on the disc (maximum of 8).
	Number of subtitle languages available on the disc (maximum of 32).
	Number of angles provided (maximum of 9).
	Aspect ratios available. "LB" stands for Letter Box and "PS" stands for Pan/Scan. In the example on the left, the 16:9 video can be converted to Letter Box video.
	Indicates the region code where the disc can be played. <ul style="list-style-type: none"> · Region 1: USA, Canada, East Pacific Ocean Islands · Region 2: Japan, Western Europe, Northern Europe, Egypt, South Africa, Middle East · Region 3: Taiwan, Hong Kong, South Korea, Thailand, Indonesia, South-East Asia · Region 4: Australia, New Zealand, Middle and South America, South Pacific Ocean Islands/ Oceania · Region 5: Russia, Mongolia, India, Middle Asia, Eastern Europe, North Korea, North Africa, North-West Asia

Notes:

Some DVD discs can be played only in certain playback modes according to the intentions of the software. As the XDVD700 plays discs according to their intentions, some functions may not work as intended. Please be sure to read the instructions provided with each disc.



DVD Operation - Inserting a Disc



Insert CD/DVD with label facing upwards

Inserting a disc

With the label facing up, insert a standard size disc into the slot. The disc will automatically begin playback. Other sub-menus may have to be pressed to access the DVD movie/music content. Read the directions of your specific DVD disc for other features.

Note: If PARENTAL Lock is activated and the disc inserted is not authorized, a 4-digit code must be entered and/or the disc be authorized. See "RATING MENU" on page 28.

Note: Only one disc can be inserted at a time.

Ejecting a disc

Press the EJECT button.

Resetting the Loading Mechanism

If the disc loads abnormally or an system error occurs, press and hold the eject button for 3 seconds to reset the loading mechanism. The disc will eject and normal operation should resume.

DVD Operation - Touch Screen Controls



Hidden Touch Screen Areas

- A - Displays **MAIN** menu
- B - Displays **DVD** disc information
- C - Selects **PREVIOUS** chapter
- D - Selects **NEXT** chapter
- E - Displays the full **DVD** transport controls
- F - **SEARCH** menu

Note:
A DVD must be inserted to access these functions and features.

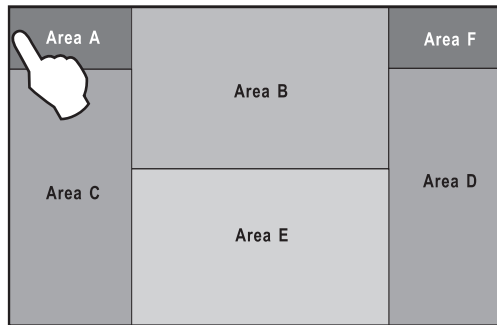

AREA A
Access MAIN Menu

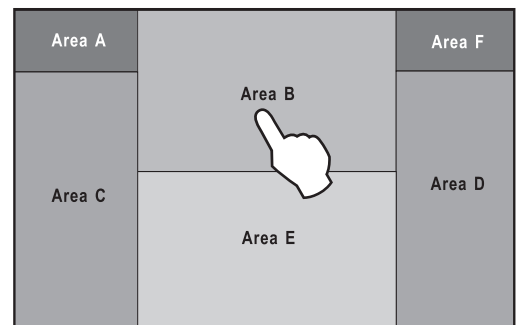

AREA B
Displays Disc Information

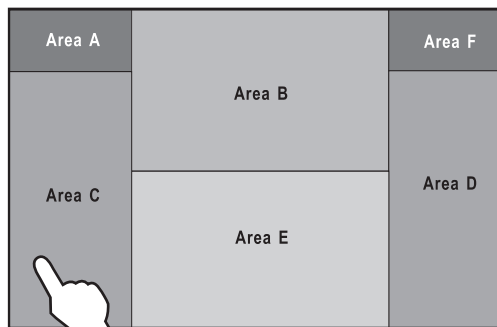

AREA C
Selects PREVIOUS Chapter/Track

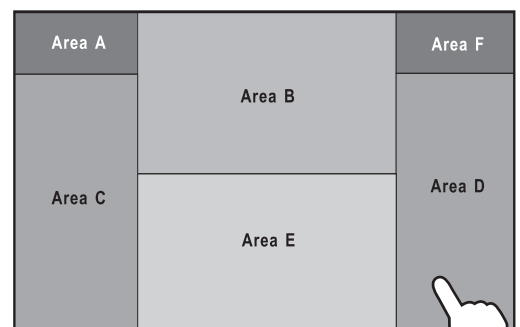

AREA D
Selects NEXT Chapter/Track

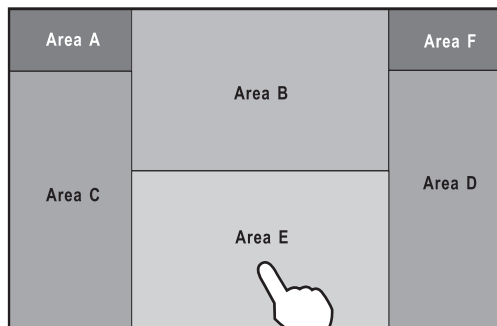

AREA E
Full DVD Transport Controls

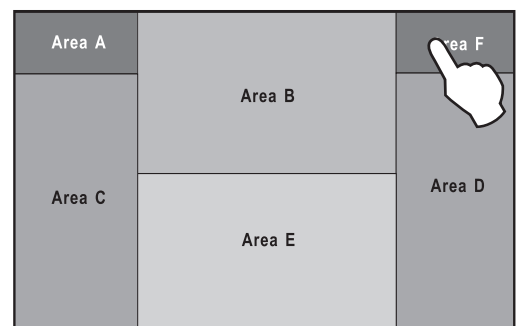

AREA F
DVD Search



DVD Operation - Touch Screen Controls

DVD Transport Controls
Area E

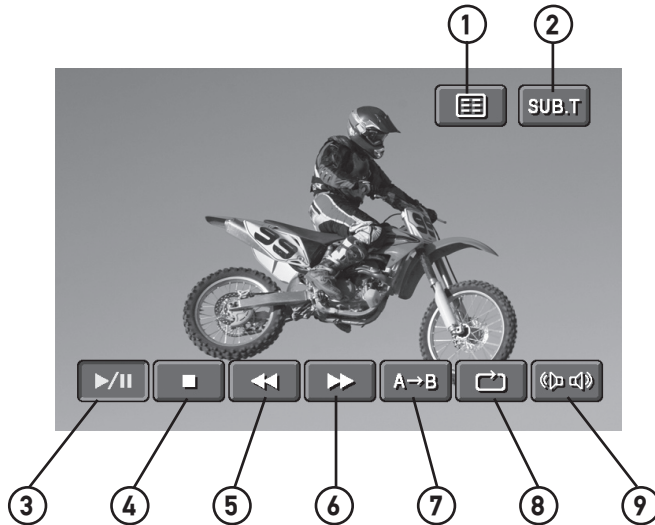

DVD Mode From the main menu, touch the DVD icon on the screen to select DVD mode.

- 1) **Title Menu**
Jumps to the DVD Title menu.
- 2) **Sub-Title Mode**
Activates sub-titles and cycles between multiple sub-title languages.
- 3) **Play/Pause**
Touch the ►/|| icon to temporarily stop or resume playback.
- 4) **Stop**
Touch the ■ icon to stop the chapter where it is.
- 5) **Fast Reverse**
Touch the ◀◀ icon to fast reverse at 2x speed.
Each touch changes speed from 2x to 4x to 8x to 16x then back to 1x play.
- 6) **Fast Forward**
Touch the ▶▶ icon to fast forward at 2x speed.
Each touch changes speed from 2x to 4x to 8x to 16x then back to 1x play.
- 7) **Repeat A-B**
Touch the A→B icon once to select a start point. Touch it a second time to select and end point. The A→B icon will illuminate and the DVD will then loop from the start point to the end point until touched a third time.
- 8) **Repeat**
Touch the ↺ icon to repeat the current chapter or title. This icon will remain highlighted until touched a third time to disable.
- 9) **Audio Mode**
Touch this icon to activate alternate audio modes on DVD's that have alternate audio streams.

DVD Operation - Searching a DVD



Searching a DVD

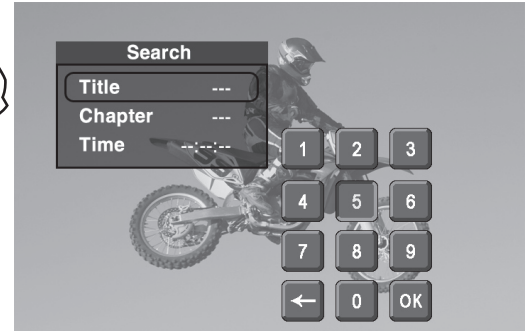
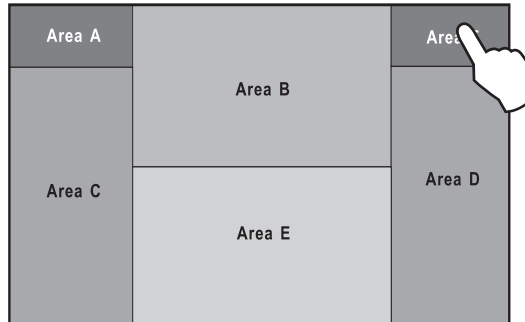

Searching by Time, Title or Chapter

Touch Area F to bring up the Search Window. The Search Window allows a search for a specific time, title or chapter.

Search by TIME example

To search for a specific time, touch the ---:---:--- area and an on-screen keyboard will pop up. Use the keyboard to enter a time and touch **OK**. (For example, to skip to 1 hour, 12 minutes and 19 seconds into the DVD, touch: **1 1 2 1 9 OK**.)

To search for a specific title and/or chapter, touch the --- / --- area and an on screen keyboard will pop up. Use the keyboard to enter a title and chapter and touch **OK**. This can be used to select a specific chapter in the current title, a new title or a specific chapter in a new title. (For example, to skip to a specific chapter within the current title, touch the --- on the right and use the keyboard to enter a chapter number, then touch **OK**.)

To skip to a different title and start from the beginning, touch the --- on the left and the keyboard to enter a title number, then touch **OK**. To skip to a specific chapter in a new title: touch the left --- and use the keyboard to enter a title number, **DO NOT** touch **OK**, then touch the right --- and use the keyboard to enter a chapter number, Then touch **OK**.)

From the remote control:

Press **SRCH** to bring up the search window, then use the arrows to highlight either the time, title or chapter field and use the numeric keypad to enter the appropriate information and press **OK**.

Notes:

Some DVD discs can be played only in certain playback modes according to the intentions of the software. As the XDVD700 plays discs according to their intentions, some functions may not work as intended. Please be sure to read the instructions provided with each disc.



DVD Operation

Playback Control	Touch Area E to bring up the on-screen buttons. Touch ►► to fast forward or ◀◀ to fast reverse.
Repeat Mode	Touch the Repeat button to repeat either a chapter or title. The first touch activates Repeat Chapter mode and a second touch activates Repeat Title mode. When either mode is active, the Repeat button will be illuminated, and touching it a third time will disable Repeat Mode .
Repeat A->B	Touch the A → B icon once to select a start point. Touch it a second time to select an end point. The A → B icon will illuminate and the DVD will then loop from the start point to the end point until touched a third time.
Play/Pause	Touching Play/Pause will temporarily stop playback of the DVD. Touching it again will resume playback. Press the PLAY/PAUSE button to pause or resume the DVD.
Stop	Touch Stop to stop playback. Pressing Play at this point will resume playback. If Stop is touched a second time, then playback stops completely and will restart from the beginning of the disc.
Sub-Titles	Touch the SUB.T button to activate Sub-Title mode and select a sub-title language. Each touch will cycle the mode from off to language 1, language 2, etc., and back to off.
Audio Mode	Touch the Audio Mode icon to change the audio stream. Each touch will cycle the language.
DVD Disc Information	Touch Area B to bring up the DVD Disc Information , which includes: Current/Total Titles and Chapters, elapsed time for current chapter, Audio setting, Angle setting and Subtitle setting. Press the PIC button to bring up the DVD Disc Information .
Zoom Mode	From the remote control: Press the ZOOM button to activate Zoom Mode . Each subsequent press of the button will change the magnification from normal to 1 to 2 to 3 and back to normal.
DVD Title Menu	Touch the Title Menu icon to return to the DVD's main menu. From the remote control: Press ROOT to move up one level on the DVD's menus. (For example, when viewing bonus materials, the ROOT button will return to the bonus menu instead of the main menu.) Pressing ROOT again will usually return to the current chapter.





CD Operation - OSD Overview



- | | |
|----------------|---|
| CD Mode | From the main menu, touch DVD icon on the screen to select CD mode. |
| 1) | Current Source Indicator
Displays source currently playing. |
| 2) | Fast Reverse
Touch the ◀◀ icon to fast reverse at 2x speed.
Each touch changes speed from 2x to 4x to 8x to 16x then to 1x play. |
| 3) | Play/Pause
Touch the ▶/ icon to temporarily stop or resume playback. |
| 4) | Disc Type Indicator
Displays the type of disc currently playing. |
| 5) | Fast Forward
Touch the ▶▶ icon to fast forward at 2x speed.
Each touch changes speed from 2x to 4x to 8x to 16x then to 1x play. |
| 6) | Track Select - Up
Touching this icon will select the next track. |
| 7) | Track Number Indicator
Displays current track number and total number of tracks on the disc. |
| 8) | Clock
Indicates current time. |



CD Operation - OSD Overview

- 9) Elapsed Time Indicator
Shows how much time has elapsed in the current track.
- 10) Current Track Indicator
Indicates current track.
- 11) Display
Press **DISP** to select between standard display and track view.
- 12) Shuffle
Touch the  icon to shuffle all tracks on the disc. This icon will remain highlighted until touched to disable.
- 13) Direct Select Keyboard
Touch the  icon to display a numeric keyboard. Enter desired track number and touch **OK** to select it.
- 14) Repeat
Touch the  icon to repeat current track. This icon will remain highlighted until touched to disable.
- 15) Scan
Touch the **SCAN** icon to listen to 10 seconds of each track in order. This icon will remain highlighted until touched to disable.
- 16) Next Page
Pressing this button will select the next available page.
This function is available in track view only. Refer to page 44.
- 17) Previous Page
Pressing this button will select the previous available page.
This function is available in track view only. Refer to page 44.
- 18) Stop
Touch the  icon to stop the song where it is.
- 19) Volume Indicator
Indicates current volume level, controlled by rotary encoder.
- 20) Track Select - Down
Touching this icon will select the previous track.

CD Operation



Playing CD-DA discs

After inserting a CD disc, files will play in numerical order.



Selecting by Keypad

Touch  to display keypad. Enter desired track number and press OK.



Selecting by Direct Track Access
Previous/Next Page

Touch desired track for DIRECT TRACK access.
Touch Page Up/Down buttons to view additional pages of available tracks.





CD Operation

Page Up/Down The Page Up and Page Down on-screen buttons can be used to see the rest of the tracks on the CD. Use the Direct Select method to play a desired track.

From the remote control:

Press ► to display the next page.

Press ◀ to display the previous page.

Track Select Press ►► button to skip to the next track.
Press ◀◀ button to skip to the previous track.

From the remote control:

Press ►► to skip to the next track.

Press ◀◀ to skip to the previous track.

Note: Press ◀◀ once to return to the beginning of the current track. Press a second time to skip to the previous track.

Direct Select To select a desired track from the track title list, touch any track on the list.

Use the Page Up and Page Down on-screen buttons to scroll through the pages. Once highlighted, simply touch the screen at the appropriate track.

Using the Rapid Dial rotary encoder:

- Select desired track by rotating the right rotary encoder clockwise or counter-clockwise.
- Press to confirm/ENTER.

From the remote control:

Press ▲ or ▼ to scroll through the tracks. When the correct track is highlighted press OK.

Direct Track Entry Touch the  icon to display a numeric keyboard. Enter desired track number and touch OK to select it.

From the remote control:

Use the numeric keypad to enter the desired track number.

Play Control You can use the Fast Forward or Fast Reverse on-screen buttons to speed up the playback of a track. Each subsequent press of the button will change the speed from normal to 2x to 4x to 8x to 16x and back to 1x.

Press ►► to fast forward.

Press ◀◀ to fast reverse.



From the remote control:

Press ►► to fast forward.

Press ◀◀ to fast reverse.

CD Operation



Shuffle Mode	<p>Touch the Shuffle button to shuffle all of the tracks on the CD. The Shuffle button will be illuminated while Shuffle Mode is active. When the button is illuminated, touching it a second time will disable Shuffle Mode.</p> <p>Notes: The shuffled order of the songs is fixed, therefore the Track Select operations will continue to operate properly within the shuffled order. Therefore using Next Track will move to the next shuffled track, while Previous Track will return to the start of the current track and then a second press will return to the previously played track.</p>
Repeat Mode	<p>Touch the Repeat button to repeat a track. When Repeat Mode is active, the Repeat button will be illuminated, and touching it again will disable Repeat Mode.</p> <p>From the remote control: Press  to select Repeat. Press it a second time to disable Repeat.</p> <p>Note: Shuffle and Repeat modes can not be used simultaneously and engaging one mode will cancel the other mode (if active.)</p>
Scan Mode	<p>Touch SCAN on the screen to listen to all tracks on the CD for 10 seconds at a time, starting from the next track on the CD. The Scan button will be illuminated while Scan Mode is active. When the button is illuminated, touching it a second time will disable Scan Mode.</p>
Play/Pause	<p>Touching Play/Pause will temporarily stop playback of the current track. Touching it again will resume playback.</p> <p>Press PLAY/PAUSE to pause or resume the song.</p> <p>From the remote control: Press OK to temporarily stop and resume playback.</p>
Stop	<p>Touch Stop to stop playback of the current track. Pressing Play at this point will resume playback. If Stop is touched a second time, then playback stops completely and will restart from the beginning of the CD.</p> <p>From the remote control: Press  to stop playback of the current song.</p>







MP3/WMA Operation - OSD Overview



- | | |
|---------------------|---|
| MP3/WMA Mode | From the main menu, touch DVD icon on the screen to select MP3/WMA mode. |
| 1) | Current Source Indicator
Displays source currently playing. |
| 2) | Fast Reverse
Touch the ◀◀ icon to fast reverse at 2x speed.
Each touch changes speed from 2x to 4x to 8x to 16x then to 1x play. |
| 3) | Play/Pause
Touch the ▶ icon to temporarily stop or resume playback. |
| 4) | Disc Type Indicator
Displays the type of disc currently playing. |
| 5) | Fast Forward
Touch the ▶▶ icon to fast forward at 2x speed.
Each touch changes speed from 2x to 4x to 8x to 16x then to 1x play. |
| 6) | File Type Indicator
Displays the type of song file, either MP3 or WMA . |
| 7) | Song Select - Up
Touching this icon will select the next song. |
| 8) | Song Number Indicator
Displays current song number and total number of songs in the current folder. |

MP3/WMA Operation - OSD Overview



- 9) Clock
Indicates current time.
- 10) Elapsed Time Indicator
Shows how much time has elapsed in the current song.
- 11) Current Filename
Indicates filename of current song.
- 12) Display
Press to select between standard display and filename view.
- 13) Shuffle
Touch the  icon to shuffle all songs on the disc. This icon will remain highlighted until touched to disable.
- 14) Direct Select Keyboard
Touch the  icon to display a numeric keyboard. Enter desired song number and touch **OK** to select it.
- 15) Repeat
Touch the  icon to repeat current song or folder. This icon will remain highlighted until touched a third time to disable.
- 16) Scan
Touch the **SCAN** icon to listen to 10 seconds of each song in order. This icon will remain highlighted until touched to disable.
- 17) Next Folder
Pressing this button will select the next available folder. This function is available in filename view only.
- 18) Previous Folder
Pressing this button will select the previous available folder. This function is available in filename view only.
- 19) Stop
Touch the  icon to stop the song where it is.
- 20) Information
Displays available information for the current song.
- 21) Volume Indicator
Indicates current volume level, controlled by rotary encoder.
- 22) Song Select - Down
Touching this icon will select the previous song.



MP3/WMA Operation

Page Up/Down

The Page Up and Page Down on-screen buttons can be used to see the rest of the songs on the disc. Use the Direct Select method to play a desired song.

From the remote control:

Press ► to display the next page.

Press ◀ to display the previous page.

Note: Continued operation of the Page Up and Page Down buttons will display the next and previous pages of available songs in the current folder.

Note: The Folder Select and Page Up/Down buttons will not select a song, but simply display more songs on the disc, and if another song is not selected within 5 seconds of the last press then the screen will return to the currently playing song/folder.

Song Select

Press ►► button to skip to the next song.

Press ◀◀ button to skip to the previous song.

From the remote control:

Press ►► to skip to the next song.

Press ◀◀ to skip to the previous song.

Note: Press ◀◀ once to return to the beginning of the current song. Press a second time to skip to the previous song.

Direct Select

To select a desired song from the filename list, touch any of the displayed filenames from the list.

Use the up and down arrows on screen to scroll through the pages of available songs. Once highlighted, simply touch the screen at the appropriate song.

Using the Rapid Dial rotary encoder:

- Select desired track by rotating the right rotary encoder clockwise or counter-clockwise.
- Press to confirm/ENTER.

From the remote control:

Press ▲ or ▼ to scroll through the songs. When the correct song is highlighted press OK.

Direct Song Entry

Touch the  icon to display a numeric keyboard. Enter desired song number and touch OK to select it.

From the remote control:

Use the numeric keypad to enter the desired song number.

MP3/WMA Operation



Song Control	<p>You can use the Fast Forward or Fast Reverse on-screen buttons to speed up the playback of a song. Each subsequent press of the button will change the speed from normal to 2x to 4x to 8x to 16x and back to 1x.</p> <p>Press ►► on to fast forward. Press ◀◀ on to fast reverse.</p> <p>Note: There is no audio output while song control is active.</p>
Shuffle Mode	<p>Touch the Shuffle button to shuffle all of the songs on the disc. The Shuffle button will be illuminated while Shuffle Mode is active. When the button is illuminated, touching it a second time will disable Shuffle Mode.</p> <p>Note: The shuffled order of the songs is fixed, therefore the Song Select operations will continue to operate properly within the shuffled order. Therefore using Next Song will move to the next shuffled song, while Previous Song will return to the start of the current song and then a second press will return to the previously played song.</p>
Repeat Mode	<p>Touch the Repeat button to repeat either a song or folder. The first touch activates Song Repeat mode and a second touch activates Folder Repeat mode. When either mode is active, the Repeat button will be illuminated, and touching it a third time will disable Repeat Mode.</p> <p>From the remote control: Press ↺ to select Song Repeat, Folder Repeat and Repeat Off modes.</p> <p>Note: Shuffle and Repeat modes can not be used simultaneously and engaging one mode will cancel the other mode (if active.)</p>
Scan Mode	<p>Touch SCAN on the screen to listen to all tracks on the CD for 10 seconds at a time, starting from the next track on the CD. The Scan button will be illuminated while Scan Mode is active. When the button is illuminated, touching it a second time will disable Scan Mode.</p>
Play/Pause	<p>Touching Play/Pause will temporarily stop playback of the current song. Touching it again will resume playback.</p> <p>From the remote control: Press OK to temporarily stop and resume playback.</p>
Stop	<p>Touch Stop to stop playback of the current song. Pressing Play at this point will resume or restart playback from the beginning of the current song. If Stop is touched a second time, then playback stops completely and will restart from the beginning of the disc.</p> <p>From the remote control: Press ■ to stop playback of the current song.</p>

Media Compatibility

Media Compatibility

The following types of discs/files are compatible:

- CD-ROM (ISO), CD-R, CD-RW, DVD+R/RW, DVD-R/RW
- CD-DA, DVD Video
- MP3 data
- WMA data

The following types of discs/files are not compatible:

- WMA files that are protected by DRM (Digital Rights Management)
- WMA lossless format
- Discs recorded with Track At Once or packet writing
- MP3 PRO format
- MP3 playlists
- WAV format
- WMV format
- JPG format
- DivX format
- AVI format
- MPG format

Some recordable DVDs and CDs may be incompatible with this unit, depending on media type and recording method.

Playback Order

MP3/WMA playback sequence is based on recorded order of files and begins in the root folder of the disc. Any empty folders or folders that do not include MP3/WMA files are skipped. This unit may not play files in the order they were recorded in. Refer to your recording software's user's manual for more information.

Compatible Recording Formats

- ISO9660 level 1
- ISO9660 level 2
- Yellow Book MODE 1
- Yellow Book MODE 2 FORM 1
- Multi session
- Maximum files - 1500
- Maximum folder levels - 8
- MPEG-1/2 Audio Layer-3

ISO9660 standards:

- Maximum nested folder depth is 8 (including the root folder).
- Valid characters for folder/file names are letters A-Z (all caps), numbers 0-9, and "_" (underscore). Some characters may not be displayed correctly, depending on the character type.
- This device can play back discs in Joliet and other standards that conform to ISO9660. MP3/WMA written in the formats other than the above may not play and/or their file names or folder names may not be displayed properly.



Media Compatibility

Additional MP3/WMA Information

An internal buffer provides ESP (Electronic Skip Protection) to virtually eliminate skipping.

When playing a disc recorded with regular audio files (CD-DA or .WAV) and MP3/WMA files, the unit will play the MP3/WMA files only.

Only MP3 files with filename extension (.mp3) can be played.
Only WMA files with filename extension (.wma) can be played.

Do not attempt to play discs which contain non-MP3/WMA files with the MP3/WMA extension.

Sampling Frequency Rates

MP3 32kHz ~ 48kHz

WMA 32kHz ~ 48kHz

Transfer Bit rates

MP3 40kbps ~ 320kbps constant
Variable bit rates

WMA 40kbps ~ 192kbps constant
Variable bit rates

Note:

Some files may not play or be displayed correctly, depending on sampling rates and bit rates.

Recommended Settings

For best results, use the following settings when burning an MP3 disc:
128kbps or higher constant bit rate
44.1kHz or higher sampling frequency

For best results, use the following settings when burning a WMA disc:
64kbps or higher constant bit rate
44kHz or higher sampling frequency

Limited One Year Warranty

This warranty gives you specific legal rights. You may also have other rights which vary from state to state.

Dual Electronics Corp. warrants this product to the original purchaser to be free from defects in material and workmanship for a period of one year from the date of the original purchase.

Dual Electronics Corp. agrees, at our option, during the warranty period, to repair any defect in material or workmanship or to furnish an equal new, renewed or comparable product (whichever is deemed necessary) in exchange without charges, subject to verification of the defect or malfunction and proof of the date of purchase. Subsequent replacement products are warranted for the balance of the original warranty period.

Who is covered? This warranty is extended to the original retail purchaser for products purchased and used in the U.S.A.

What is covered? This warranty covers all defects in material and workmanship in this product. The following are not covered: installation/removal costs, damage resulting from accident, misuse, abuse, neglect, product modification, improper installation, incorrect line voltage, unauthorized repair or failure to follow instructions supplied with the product, or damage occurring during return shipment of the product.

What to do?

1. Before you call for service, check the troubleshooting guide in your owner's manual. A slight adjustment of any custom controls may save you a service call.
2. If you require service during the warranty period, you must carefully pack the product (preferably in the original package) and ship it by prepaid transportation with a copy of the original receipt from the retailer to an authorized service center.
3. Please describe your problem in writing and include your name, a return UPS shipping address (P.O. Box not acceptable), and a daytime phone number with your shipment.
4. For more information and for the location of the nearest authorized service center please contact us by one of the following methods:
 - Call us toll-free at 1-866-382-5476
 - E-mail us at cs@dualav.com

Exclusion of Certain Damages: This warranty is exclusive and in lieu of any and all other warranties, expressed or implied, including without limitation the implied warranties of merchantability and fitness for a particular purpose and any obligation, liability, right, claim or remedy in contract or tort, whether or not arising from the company's negligence, actual or imputed. No person or representative is authorized to assume for the company any other liability in connection with the sale of this product. In no event shall the company be liable for indirect, incidental or consequential damages.



Troubleshooting

Problem	Cause	Action
Unit will not turn on (no power)	Yellow wire not connected or incorrect voltage Red wire not connected or incorrect voltage	Check connections for proper voltage (11~16VDC)
	Black wire not connected	Check connection to ground
	Fuse blown	Replace fuse
Unit has power (but no sound)	Speaker wires not connected	Check connections at speakers
	One or more speaker wires touching each other or touching chassis ground	Insulate all bare speaker wires from each other and chassis ground
Unit blows fuse	Yellow or red wire touching chassis ground	Check for pinched wire
	Speaker wires touching chassis ground	Check for pinched wire
	Incorrect fuse rating	Use fuse with correct rating
Unit has audio (but no video)	Parking brake safety circuit not connected Parking brake not applied	Check connections at parking brake Apply parking brake as described on page 34
No video display (when in reverse)	Reverse circuit not connected Vehicle is not in reverse	Check connections at reverse lamp Select reverse gear
DVD does not start playback	Physical defect in media Wrong region	Check media for scratches Use discs labeled "Region 1" or "All" only.
IR remote does not work	Dead battery	Replace battery
Excessive skipping	Unit is not mounted correctly	Check mounting sleeve
	Physical defect in media	Check media for scratches
Bad Disc appears on display	Focus error or disc is in upside down	Press eject or RESET
Incorrect Region Code appears on display	Region code error	Use only DVDs labeled "Region 1" or "All" only.
Front panel will not open/close	Front panel obstructed	Remove the obstacle and press OPEN again to resume the monitor open/close sequence.

Specifications

DVD Player	<p>Frequency response: 10Hz-20kHz Channel separation @ 1kHz: >60dB D/A converter: 24 Bit</p>
FM Tuner	<p>Tuning range: 87.5MHz-107.9MHz Usable sensitivity: 8.5dBf 50dB quieting sensitivity: 10dBf Stereo separation @ 1kHz: 40dB Frequency response: 30Hz-13kHz</p>
AM Tuner	<p>Tuning range: 530kHz-1710kHz Usable sensitivity: 22uV Frequency response: 30Hz-2.2kHz</p>
Monitor	<p>Panel size: 7" (177.8 mm) diagonal measurement View angle (up/down/left/right): 30/60/60/60 Resolution: 480 W x 234 H Brightness (cd/m²): 300 Contrast ratio: 300:1 Elements: 336,960</p>
General	<p>Operating voltage: 11-16 VDC, negative ground Speaker output impedance: 4~8 ohms Line output voltage: 2 Volts Line output impedance: 200 ohms Chassis dimensions: 7" x 7" x 2" (178 x 178 x 51 mm)</p>

Design and specifications subject to change without notice.



CEA-2006 Power Standard Specifications
 (reference: 14.4VDC +/- 0.2V, 20Hz~20kHz)

Power Output: 17 Watts RMS x 4 channels at 4 ohms and ≤ 1% THD+N
 Signal to Noise Ratio: 80dBA (reference: 1 watt into 4 ohms)

Dual Electronics Corp.
Toll Free: 1-866-382-5476

www.dualav.com
©2007 Dual Electronics Corp. All rights reserved.
NSA0707-V1.1
Printed in China